



**shamir**

Perfect vision  
Personal touch



**Dear Eye Care Professional Partner,**

The Shamir catalog presents our extensive product range, together with the company overview, marketing materials, and sales information. **All in one comprehensive kit.**

We've been listening to your issues and challenges, and this catalog has been designed to address your needs.

"We are pleased to introduce an entirely new Shamir logo and brand message," said Raanan Naftalovich, President of Shamir Insight, North America. "While our mission to ReCreate Perfect Vision has not changed, our modern and innovative identity better captures the spirit of our dynamic company."



**shamir**

**Perfect vision. Personal touch**



# Company Profile

Perfect vision. Personal touch





# Facts & figures



**A leading innovator**  
in ophthalmic lens technologies, and a top manufacturer of high quality progressive and single vision lens solutions

~ **2,500**

Employees worldwide

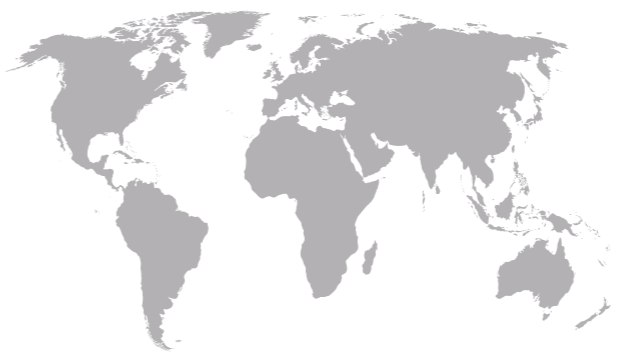

## Global reach

Marketing operations in more than 20 countries

Over **300**



Authorized Shamir Labs

**\$284 M**

in sales (2019)



## The gift of perfect vision

Sight is by far the most important of human senses, with the majority of our perception conveyed by the eyes, and the brain devoting more space to handling of visual input than to all other senses combined.

Many born with perfect vision may take it for granted, yet nearly two thirds of the world's population – that's approximately 4.5 billion people – suffer from some form of vision impairment.

Shamir is dedicated to advancing vision correction through innovation that not only recreates perfect vision, but also with the most advanced materials and coatings.



## Pioneering vision solutions aligned with patient needs



At Shamir, we believe everyone is entitled to perfect vision – and that’s exactly what our unparalleled lens technologies and products are designed to deliver.

Established in 1972 to manufacture bifocal lenses, Shamir is a leading producer of advanced single vision and progressive lenses. Over nearly five decades, the company has successfully solidified its global market position as a truly cutting-edge innovator, with the highest of quality assurance standards.

We have built our reputation on our perceptiveness to human vision challenges and pain points, and on our creativity and success in pioneering powerful vision technologies that can help overcome them. We ultimately pride ourselves on our truly robust product portfolio, which harnesses these technologies to address an unparalleled range of human vision needs.

A product of the Israeli “startup nation”, we prioritize and invest heavily in research and development, employ the very best minds in the industry, and have achieved numerous scientific and development breakthroughs that have placed us right at the forefront of optical technology. Our R&D efforts exceed development of visual acuity enhancing technologies, and additionally focus on supporting ECPs (Eye Care Professionals) with the products, knowledge and tools they require to enhance their brand and grow their business.

Shamir is known for revolutionizing customer experience’s with advanced technologies and outstanding customer service.

We’re here to help ECPs, labs, and patients to broaden their range of optics – which include Everyday, Work and Play vision solutions.



## A comprehensive product portfolio

Our goal is to drive our ECP customers' success with best-in-class products and innovative optical solutions, all globally backed by the closest personal support.

Our state-of-the-art, worldwide award-winning Autograph Intelligence™ lenses represent a true revolution in intelligent vision design. Incorporating technology leveraging artificial intelligence to accurately model Big Data collected on actual eyeglass wearers' head and eye movements, they are designed to optimally accommodate any age- or usage-driven need.

Our deep understanding and desire to address basic eyewear needs are clearly reflected in our truly diverse range of task-specific lenses, which make reading, computer and handheld digital device use, active lifestyles, and more easier and more comfortable than ever.



Shamir is known for its groundbreaking optometric measurement solutions. With a broad range of single vision and progressive lenses to suit your lifestyle, as well as the most advanced aesthetic and protective coatings – Shamir's staggering selection of high quality products has you fully covered.





## Our technology leadership mission

Shamir prides itself on being at the forefront of optical technology, with our R&D mission dedicated to outstanding service, superior product performance and technological excellence.

### Remaining ever perceptive to customers' visual needs

Our primary goal is and always has been to resolve vision and related human challenges. We will always listen to, and do our best to fully understand and adapt to continuously evolving consumer and ECP needs.

### Raising the bar with pioneering spirit

We have a strong passion for innovation, and work through a rigorous R&D process utilizing market research to understand and develop solutions for consumer pain points. It's in our DNA to challenge the status quo and produce breakthrough technologies that can literally bring about a quantum leap in ophthalmic lens capabilities.

### Maintaining a truly panoramic portfolio of perfect vision offerings, backed by unparalleled service excellence

We've built our reputation on delivering and continuously expanding the most comprehensive range of best-in-breed products optimally addressing any and all vision needs.





# Global presence

Our worldwide reach, extending across Europe, America, Asia Pacific, Africa and the Middle East, not only provides the close proximity required to best support ECPs and customers in their own countries. It also grants our entire organization and ECP customer base uniquely global perspective. It serves as a basis for beneficial regional cooperations and truly local focus, both of which make it possible for us to optimally adapt our product offerings to the needs and requirements of specific geographies and – most importantly – individual customers.

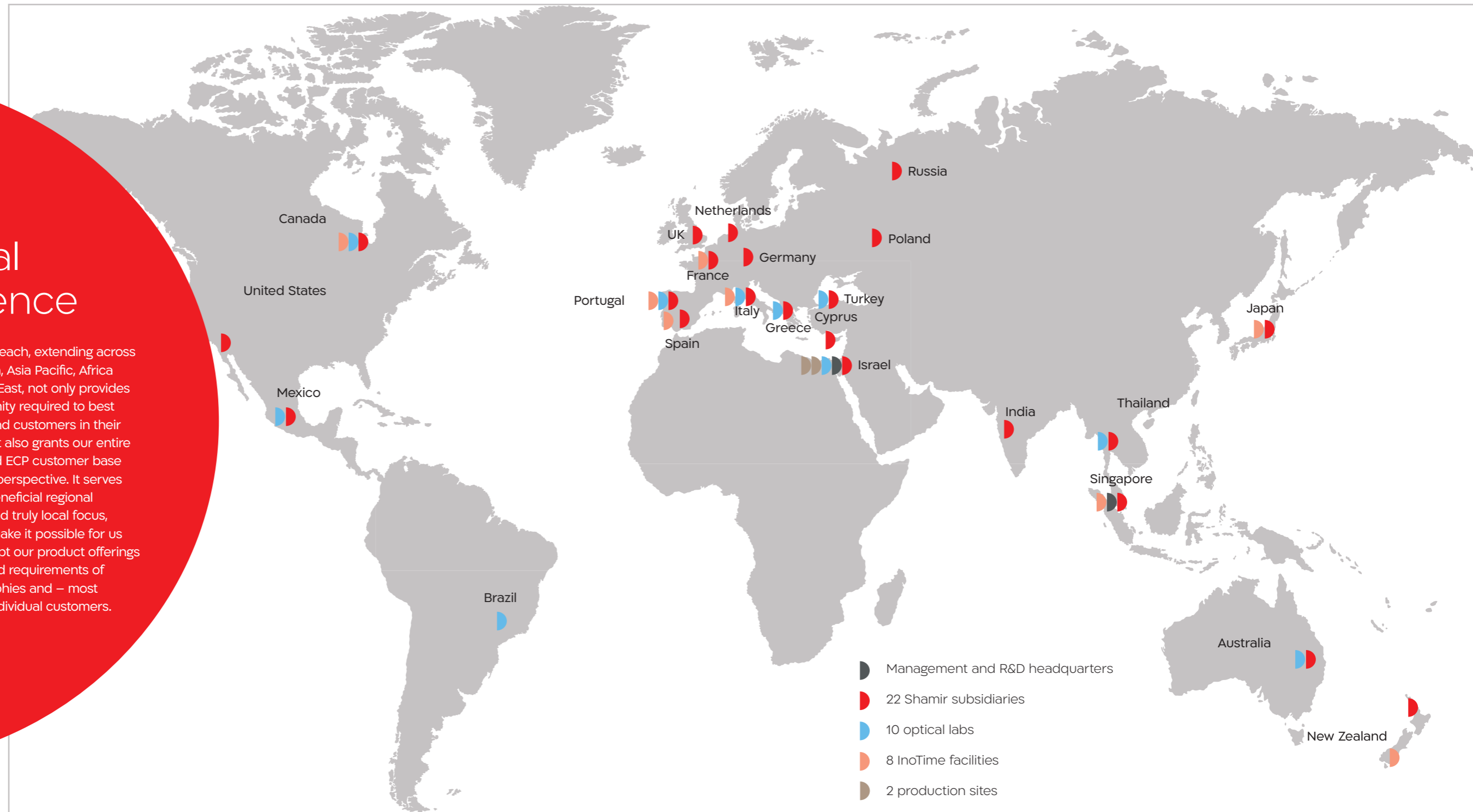



## Our partnership

Our message to eye care professionals is loud and clear. We see you, and are here to help you compete and grow your business in an increasingly challenging market landscape.

While excellent products are naturally a must-have, to us, there's unquestionable beauty in the highest quality service, too. We're set to provide every bit of training, education and support you may require to deliver the best possible visual solutions and experience to your customers.

After all, your business goals are equally ours. We'll share the knowledge and expertise you need to overcome challenges, minimize customer non-adapts and increase sales.

Each and every one of our representatives is personally committed to your vision, and will provide the service and support required to make it happen.





# Technologies & Lenses



Our Range  
of Products

## TECHNOLOGIES

Eye-point Technology AI™	1-2
Eye-point Technology III™	3-4
Continuous Design Technology™	5
Visual AI Engine™	6
Natural Posture™	7
Intellicorridor™	8
As-worn Quadro™	9
Close-up™	10

## EVERYDAY LENSES

Shamir Autograph Intelligence™	13-14
Shamir Autograph III™	15-16
Shamir Autograph II+™	17-18
Shamir Autograph InTouch™	19-20
Shamir Spectrum+™	21-22

## WORK LENSES

Shamir Computer™/Workspace™	25-26
-----------------------------	-------

## PLAY LENSES

Shamir Attitude III Sport™	29-30
Shamir Attitude III Fashion™	31-32

## SINGLE VISION LENSES

Shamir Autograph III™ - SV	35-36
Shamir Relax™	37-38
Shamir Autograph II™ - SV	39-40
Shamir Attitude III SV™	41-42

## BIFOCAL LENSES

Shamir Duo™	45-46
-------------	-------

## DEVICES

Spark Mi Up™	49-50
--------------	-------



# Groundbreaking Technologies

We are the recognized world leader in custom-designed lens technology that ensures both wearer comfort and optimized visual acuity for virtually any prescription, in any shape frame.



## Eye-point Technology AI™

Utilizing Head Eye Integrative Movement software (HEIM), Shamir can now see exactly where in the lens patients actually look, along both the vertical and horizontal meridians, when they specifically perform tasks in the various visual zones. This technology enables us to design a lens that takes into account actual viewing angles computed for every distance.



## Eye-point Technology III™

By enabling the delivery of personalized lenses with wide, distortion-free viewing fields, this technology has standardized lenses for both hyperopic (farsighted) and myopic (nearsighted) eyeglass wearers. Relying on precise measurements and prescriptions, and on simulation of perceived, real-world viewing fields, the technology enables lens designers to achieve precise power profile control, and apply specific power emphasis at different points and vision zones across lens surfaces.



## Continuous Design Technology™

This technology integrates research findings with patient habits and visual needs to provide a smooth, seamless lens design concept for every Visual Age™. Shamir can now offer a unique lens design ideally suited for every Visual Age™ in all vision zones, and for all distances that also ensures an easy transition to eyeglass wearers' next lenses in line as they age.



## Visual AI Engine™

By applying elements of Artificial Intelligence that mimic human intelligence, Shamir's Visual AI Engine™ makes each lens specific to how each individual will use it. Automated and significantly accelerated development and personalization technology enabling continuous, first-to-market provision of lenses most precisely tailored to the needs of numerous predefined visual age ranges.



## Eye-point Technology™

By analyzing data from over 3,600 points on each lens Shamir is able to create lenses that offer patients a more accurate and comfortable visual experience.



## Natural Posture™

This technology enables the delivery of ergonomic lens designs by ensuring the most comfortable viewing postures, specifically when reading and viewing nearby objects.



## Intellicorridor™

Technology facilitating precise power control along the entire eye convergence path, for production of lenses that optimally accommodate intermediate vision-dependent tasks, support digital device users without compromising far vision, and ensure smooth transition among all vision zones.



## As-worn™

Technology using three different measurements to create a lens that's even better suited for the patient; with vertex distance, pantoscopic tilt and panoramic angle we can fine-tune the lens unlike ever before.



## As-worn Quadro™

The technology facilitates precision personalization and customization of lenses to specific frame shapes and tilt angles, and to their distance from wearers' eyes. It ultimately ensures that the right power corrections established to be required in ECP measurements are maintained without compromise in eyeglass wearers' own frame of choice.



## Close-up™

This technology adjusts the reading zone inset of the lens to each individual patient's convergence during near viewing. This creates a lens that meets individual differences, from physiological traits such as distance between pupils, length of arms, or convergence/divergence disorders, to life style, type of work, hobbies, and so on. The result is a highly personalized lens that meets today's visual performance demands, whether average or irregular, for near and intermediate viewing.



Eye-point Technology AI™



## Groundbreaking head and eye motion-based vision modeling technology

Eye-point Technology AI is Shamir's premium lens design technology. It goes beyond traditional measurements and simulations, and incorporates artificial intelligence to accurately model Big Data collected on actual eyeglass wearers' head and eye movements, as part of the lens design process.

The technology allows Shamir's lens developers to precisely predict and accommodate exactly where and how eyeglass wearers of different ages gaze through their lenses – across both vertical and horizontal meridians – so as to optimally assist them in the diverse tasks they need to perform under varying circumstances.

### Main Benefit

The ability to produce the most advanced and precisely personalized progressive lenses that deliver optimal visual experience for any age- and usage-driven requirement.



Eye-point Technology III™

## Precise measurement- and simulation-based lens personalization technology

Eye-point III is technology enabling delivery of personalized lenses with wide, distortion-free viewing fields, standardized for both hyperopic (farsighted) and myopic (nearsighted) eyeglass wearers.

Relying on precise measurements and prescriptions, and on simulation of perceived, real-world viewing fields, the technology enables lens designers to achieve precise power profile control, and apply specific power emphasis at different points and vision zones across lens surfaces.

### Main benefit

The ability to produce lenses enabling eyeglass wearers with any prescription and frame choice to achieve clear and comfortable visual experience, while ensuring the most natural viewing postures and accommodating the increasing use of handheld digital devices.





## Continuous Design Technology™

# Technology enabling delivery of multi-concept lens designs improving the vision of eyeglass wearers of any age

Continuous Design technology is Shamir's way of most efficiently and effectively delivering different lens designs that accommodate eyeglass wearers of different ages and visual needs.

Rather than serve eyeglass wearers of all ages and usage patterns with one and the same lens design, the technology enables Shamir designers to deliver a single concept encompassing twelve unique designs, each tailored exactly to the needs of one of twelve pre-established age ranges.

### Main Benefit

The capability to provide and very rapidly adapt different lenses optimally matching both current and evolving needs, and ensuring easy transition to eyeglass wearers' next lenses in line as they age.



## Visual AI Engine™

# Technology for automation and significant acceleration of personalized lens development

Shamir's Visual AI Engine is a Big Data- and artificial intelligence-driven lens design technology. It is crucial to our Continuous Design approach, which enables Shamir lens designers to establish and deliver twelve unique lens variations within a single concept, all tailored precisely to the needs and usage habits of twelve specific age ranges.

Developing a large number of variants from prototype to final design would normally require a vast amount of time. However, with Visual AI Engine's autonomous optimization of spheres, addition powers, face-form angles, pantoscopic tilts, fitting heights, base curves, indexes and more, and its automated self-checks, our developers are able to dramatically accelerate this process, and cut down lens development time by years.

### Main benefit

The ability to continuously be first-to-market with the most advanced lenses, designed with the greatest accuracy to match the needs of a range of different visual ages.

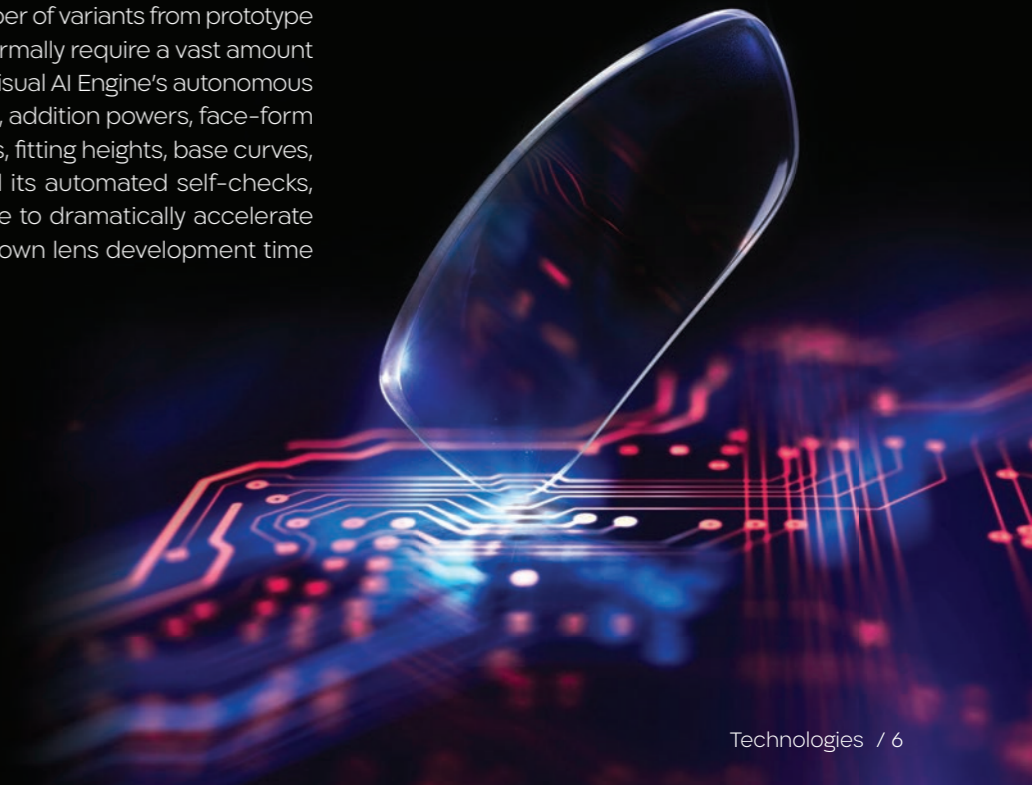





Natural Posture™

## Technology enabling delivery of ergonomic lens designs for the most comfortable viewing postures

Natural Posture is an innovative ergonomic design technology enabling development of lenses that optimally accommodate eyeglass wearers' head posture when reading or focusing on nearby objects.

The technology enables Shamir developers to dynamically position near viewing zones on lens corridors, while precisely adhering to prescribed positive or negative power profiles, so as to optimize vertical head and eye motion and ensure maximum viewing comfort in these zones.

### Main benefit

The ability to produce lenses that maximize individual postural comfort when reading and viewing nearby objects, while minimizing the need to raise or lower items, or tilt one's head up or down – ideal for anisometropic eyeglass wearers, whose eyes focus unevenly and who require varying accommodative eye support.



Intellicorridor™

## Technology allowing precise power control for clear vision along the entire eye convergence path

Intellicorridor is technology enabling strict control over power profiles implemented along the eye's visual path across a progressive lens' vertical meridian, or corridor.

The technology grants Shamir lens developers full control in optimally applying variable power emphasis to any number of eye convergence points and vision zones on the lens surface. It additionally enables provision of dedicated support for modern lifestyle near vision tasks, such as frequent use of tablets and smartphones.

### Main Benefit

The ability to produce lenses that optimally accommodate a range of common intermediate vision-dependent tasks and activities, enable easy adaptation for digital device users without compromising far vision, and ensure smooth transition among all vision zones.



As-worn Quadro™

## Technology ensuring optometrist measurement-faithful visual experience in any frame of choice

As-worn Quadro technology enables Shamir lens developers to ensure that the exact same visual clarity and comfort eyeglass wearers experience with trial frames on conclusion of optometrist eyesight measurements is maintained when their new lenses are fitted into their frames of choice.

The technology facilitates precision personalization and customization of lenses to specific frame shapes and tilt angles, and to their distance from

wearers' eyes. It ultimately ensures that the right power corrections established to be required in ECP measurements are maintained without compromise in eyeglass wearers' own frame of choice.

### Main Benefit

The ability to produce lenses with greatly reduced sensitivity to frame tilt variations, that deliver enhanced visual performance in any chosen frame.



Close-up™

## Lens personalization technology ensuring maximum near and intermediate visual comfort

Shamir's Close-up technology allows adjustment and precise correlation of lens reading and intermediate vision zone insets to individual eyeglass wearers' specific eye convergence or divergence, as well as to the distance between their pupils, the length of their arms, their lifestyles, work habits and more. This ultimately enables delivery of the perfect balance between visual clarity and ergonomic comfort.

### Main benefit

The ability to deliver lenses that fully accommodate natural eye focusing motions, ensure near and intermediate vision clarity, and maximize viewing comfort by precisely matching the specific physiological properties of individual eyeglass wearers' eyes.

# Everyday Lenses

Shamir Autograph Intelligence™

Shamir Autograph III™

Shamir Autograph II+™

Shamir InTouch™

Shamir Spectrum+™

# The artificial intelligence-driven lens of the future made available today

## What it is

The first progressive lens of its kind optimally tailored to individual eyeglass wearers' needs and visual age (the physiological age of one's eyes) via AI (Artificial Intelligence). Shamir Autograph Intelligence achieves this highest precision match via extensive research of consumer preferences and age-specific use of different vision zones, and implementation of innovative Big Data- and AI-assisted lens design.

Autograph Intelligence overcomes the limitations of traditional progressive lenses, which feature identical concepts for all ages and addition powers, with the most precisely personalized lens designs. It utilizes the power of AI to deliver twelve unique and innovative progressive lens concepts, each carefully tailored to the needs of specific visual ages and zone usage profiles.

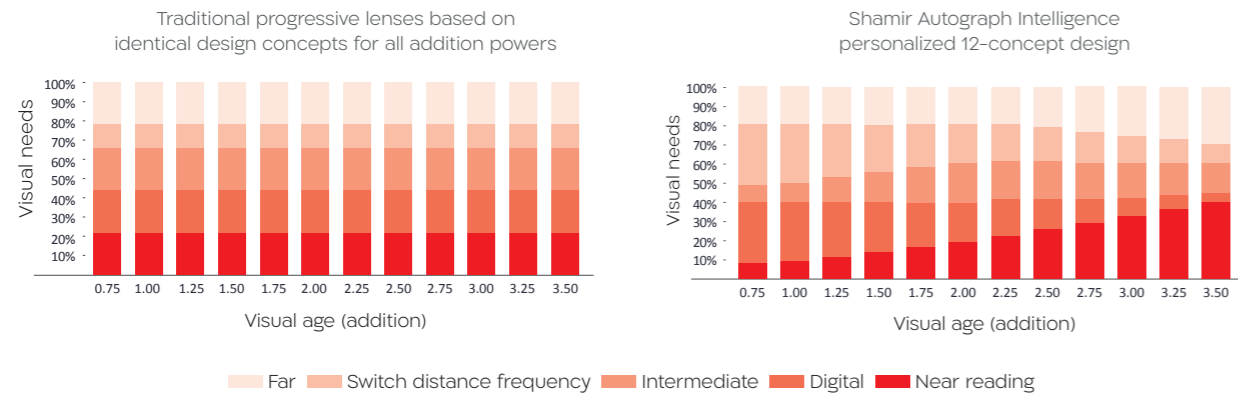

## Benefits

- The most precise fit to visual-age specific needs
- Clear and seamless (single vision lens-like) visual experience
- Seamless transition among vision zones
- Optimal visual experience with any frame of choice
- Maximum postural comfort via significant reduction of undesirable head movements
- Digital (handheld device and computer) viewing zone support

## Who it's for

Eyeglass wearers experiencing increasing difficulty reading small print, suffering from eyestrain and headaches, and demanding the most technologically advanced, and most precisely personalized lenses.

Featured technologies



# A premium progressive lens offering optimal personalized visual experience across all zones

## What it is

A premium progressive lens developed on the basis of precise measurement of individual prescriptions and simulation of perceived, real-world viewing fields, to deliver clear vision, with seamless gradation across all vision zones.

Autograph III delivers wide, distortion-free viewing fields, completely standardized for both hyperopic (farsighted) and myopic (nearsighted) eyeglass wearers. It implements precise power profile control, with specific power emphasis at different points and vision zones across the entire lens surface, and enables optimal adaptation to prescriptions and choices of frame.

Autograph III additionally accommodates the most natural and ergonomic viewing postures, helping to reduce the need to tilt one's head forward or back, or lower or raise objects to achieve convenient viewing. It even addresses the near and intermediate vision zone requirements of modern lifestyle activities, such as the use of digital devices.

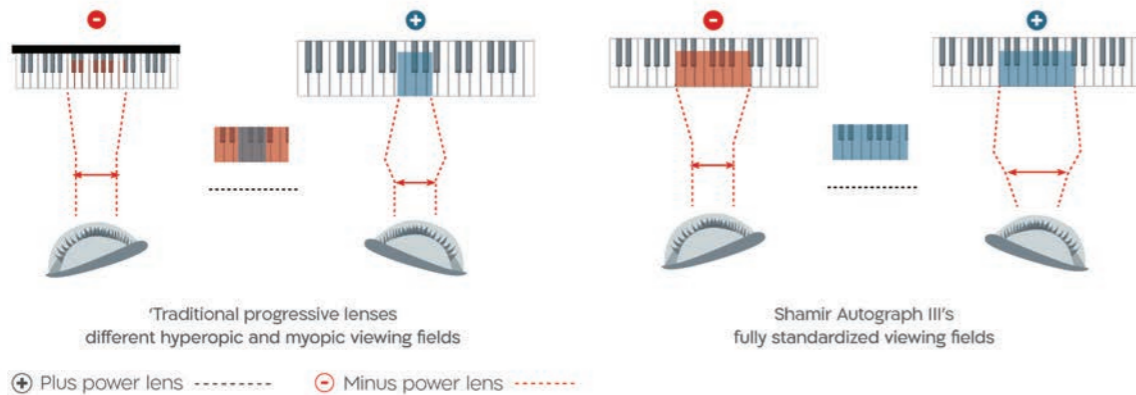

### Featured technologies



## Benefits

Near vision enhancement, with instant focus across all zones

Seamless transition among vision zones

Optimal visual experience with any frame of choice

Maximum postural comfort via significant reduction in undesirable head movements

Digital (handheld device and computer) viewing zone support

## Who it's for

Eyeglass wearers experiencing difficulty reading small print, focusing on nearby objects, or suffering from eyestrain and headaches, and demanding premium lenses that optimally accommodate any individual prescription.

## Tailored for your everyday

### What it is

Shamir Autograph® II+ provides patients with more comfort both ergonomically and visually for everyday needs. These back-surfaced, digital Freeform® lenses can be personalized for your patients thanks to four of Shamir's advanced technologies: EyePoint Technology®, As-Worn Technology™, Natural Posture™, and Close-Up™.

Autograph® II+ provides wider fields of view, and is designed to be more ergonomically comfortable while reading, working, and doing other various everyday tasks.

Most lens designs are "universally optimized" for near viewing, with an average inset value, which is fine in most cases. However, when it comes to any irregularities, near vision may be unfocused or

narrow. With Autograph® II+ the near viewing zone is dynamically located within the lens corridor, taking into account the Rx sphere value - plus or minus, and giving constant, clear focus. It also reduces the need to tilt the head forwards or backwards or alternatively to lower or raise a book when reading to find the right viewing distance and angle.

### Benefits

The reading area is optimally positioned, so you'll enjoy a more natural posture.

Personalized to meet your precise visual needs based on your visual requirements, chosen frames and wearing style.

Constant, clear focus regardless of transitioning from near to intermediate views.

### Who it's for

Task-oriented eyeglass wearers experiencing blurry vision when focusing on objects at different distances. It's effective for avid readers or writers, digital users, those who enjoy hobbies such as painting, or even just working in an office.

# A progressive lens perfecting vision for the digital age

## What it is

An advanced and highly flexible everyday progressive lens designed to significantly improve visual clarity in the 15-to-27-inches digital device viewing zones.

With a power profile uniquely optimized to eyeglass wearers' head, eye and hand postures, Autograph InTouch delivers visual clarity in all vision zones. It additionally features specific, enhanced support for near, 15-to-27-inches digital device usage zones, facilitating both traditional book and computer display reading, and digital lifestyle-driven smartphone and tablet usage. The lens' extra soft design ensures easy transition among all viewing zones.

## Who it's for

Eyeglass wearers with modern lifestyles, who frequently use digital devices and expect the highest visual comfort.



Digital handheld device viewing field afforded by traditional progressive lenses



Enhanced digital handheld device viewing field delivered by Shamir Autograph InTouch

Featured technologies



## Benefits

Unprecedented support for near zone computer and handheld digital device viewing

High visual clarity in all vision zones

Seamless transition among vision zones

## A powerful progressive reading lens

### What it is

A progressive lens that delivers sharp and comfortable visual experience, with broad near reading zones, and strong personalization to customers' individual reading posture.

Shamir Spectrum+ is an ergonomic everyday lens that delivers improved visual experience in both near and far vision zones. It features Shamir's unique Natural Posture technology, which helps overcome traditional progressive lens limitations to accommodate eyeglass wearers' most natural viewing posture.

The technology effectively reduces the need to tilt one's head forward or back, or lower or raise objects to achieve convenient viewing, all while optimally accounting for positive or negative power adjustments.

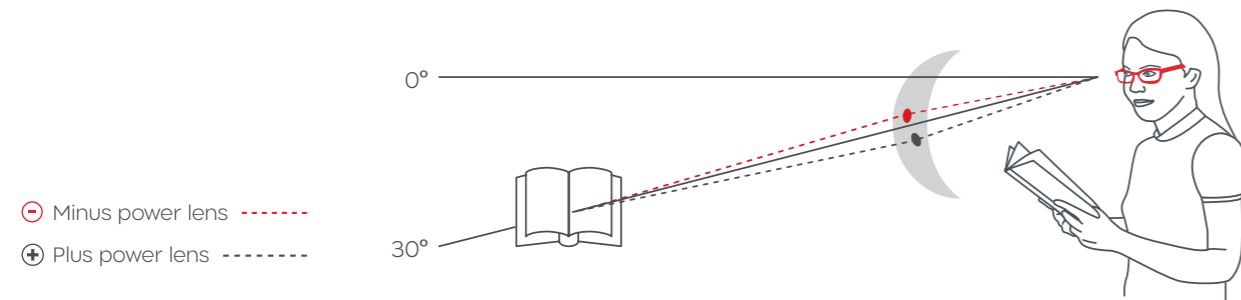

Featured technologies

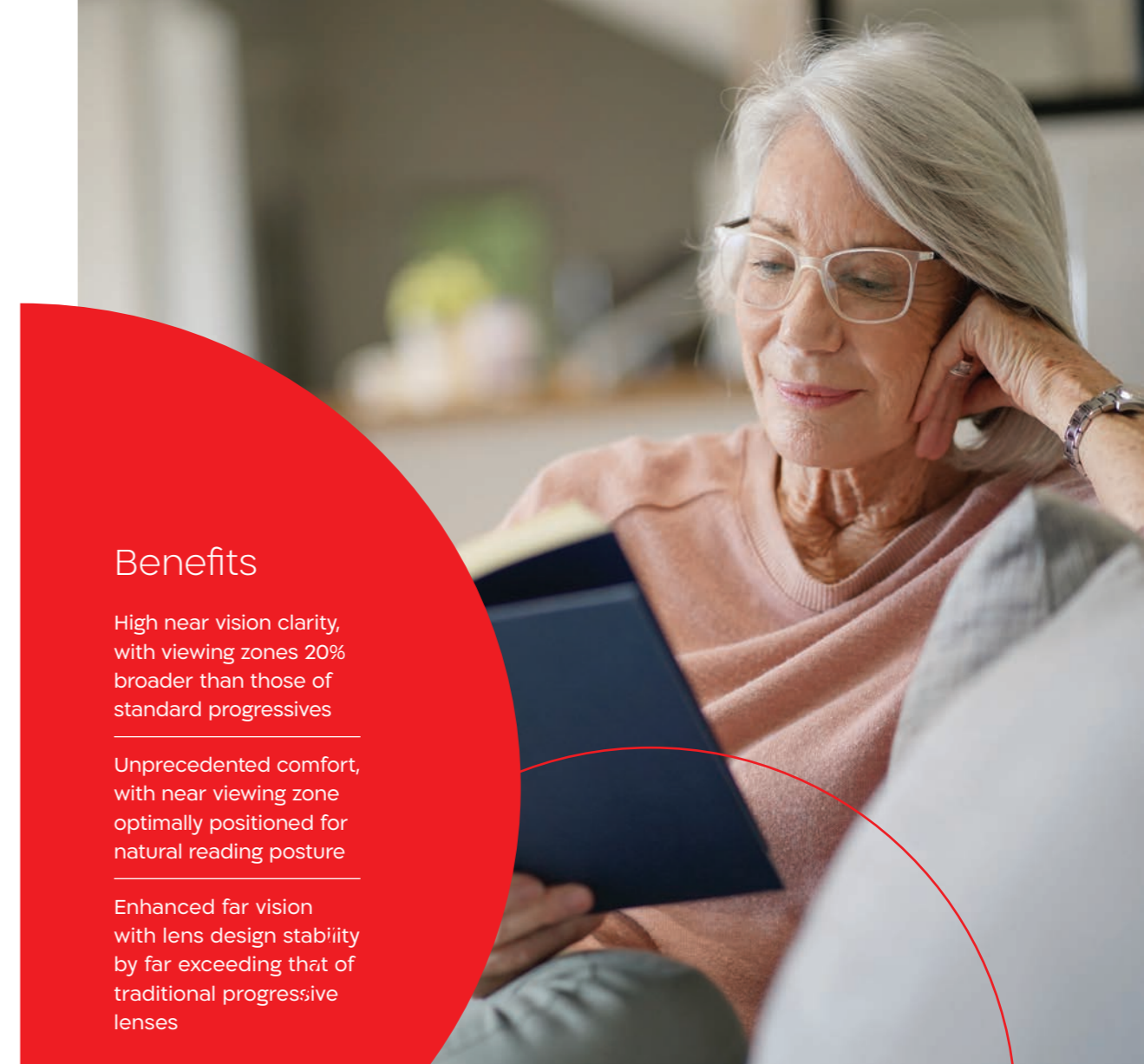

### Benefits

High near vision clarity, with viewing zones 20% broader than those of standard progressives

Unprecedented comfort, with near viewing zone optimally positioned for natural reading posture

Enhanced far vision with lens design stability by far exceeding that of traditional progressive lenses

### Who it's for

Cost-conscious eyeglass wearers requiring visual clarity and comfort across all zones, and specifically when reading books and focusing on nearby objects.



# Work Lenses

Shamir Computer™ / Workspace™

# Lenses providing optimal visual experience in desktop computing and workspace environments

## What it is

Lenses designed to significantly improve visual clarity and comfort in the 5 ft - 10ft range.

Shamir Computer and Workspace lenses feature power profiles uniquely optimized for near vision zones. Suitable for small, closed off workspaces, Shamir Computer provides visual clarity and comfort in the 5 feet range typically required for convenient reading and computer usage.

Shamir Workspace offers similar functionality, while extending visual reach for larger offices and open spaces, and delivering visual comfort at even greater distances ranging up to 10 feet. Both lenses accommodate the most natural and ergonomic viewing postures, helping to reduce the need to tilt one's head forward or back, or lower or raise objects to achieve convenient viewing.



Enhanced 5 ft viewing field provided by Shamir Computer lens

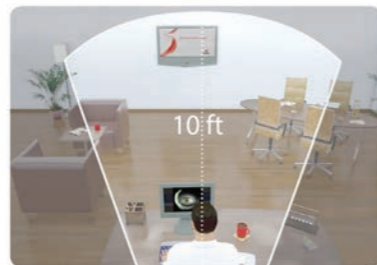

Enhanced 10ft viewing field provided by Shamir Workspace lens

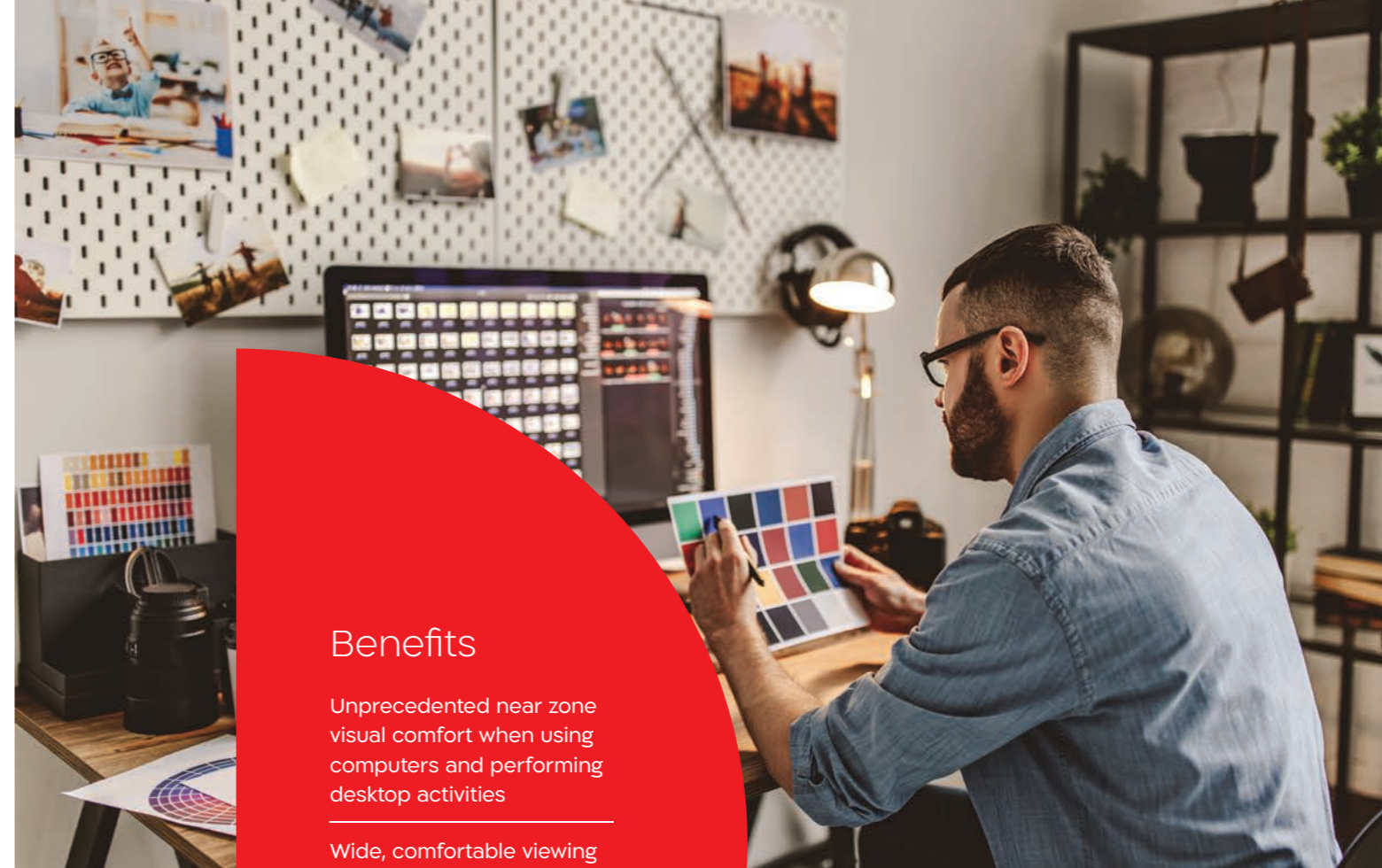

## Benefits

Unprecedented near zone visual comfort when using computers and performing desktop activities

Wide, comfortable viewing field for reading

Natural and ergonomic viewing postures

Reduced eye strain and fatigue

## Who it's for

Reading, bifocal or progressive eyeglass wearers requiring vision improvement in near vision zones when spending the majority of their workday at their desk and in front of computers.

Featured technologies



# Play Lenses

Shamir Attitude III Sport™

Shamir Attitude III Fashion™

## A progressive sunglass lens for sports and active lifestyles

### What it is

A progressive performance sunglass lens prescription-tailored to deliver clear undistorted vision, specifically in the zones characteristically focused on by people engaged in sports and in active lifestyles.

Shamir Attitude III Sport delivers distortion-free visual experience, specifically in vision zones crucial to sports and active lifestyles, while maintaining full clarity and stability even when performing sharp, rapid motions. It features an outstanding soft design, and incorporates moderate power increases to ensure clear and stable vision in crucial zones, both above and below the 180 degree line.

The lens ultimately enables clear vision anywhere – from the near zone used to view fitness bands and smartwatches, through the 3-to-16 feet “safety zone” athletes focus on to plan their next moves, and all the way to the expanded peripheral zones of curved sunglass frames.

### Who it's for

Sunglass wearers who expect the best possible visual experience in sports and outdoor activities with ANY size or shaped frame, even curved ones.

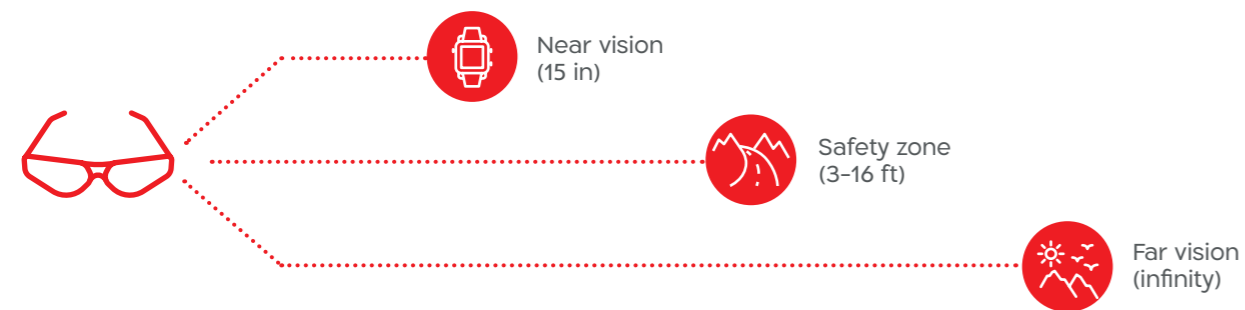

Featured technologies



### Benefits

Optimal visual experience with curved sunglass frames

Instant focus and clear vision in intermediate (safety), far and peripheral vision zones, with dedicated support for near zone use of fitness bands and smartwatches

Seamless transition among vision zones



## A progressive sunglass lens for any fashion frame

### What it is

A progressive sunglass lens precisely tailored to the individual prescriptions and dynamic vision zones of customers engaged in a modern lifestyle, and ensuring clear, undistorted visual experience outdoors, in sunglass frames of any size and curvature.

Shamir Attitude III Fashion delivers clear and distortion-free, prescription-personalized visual experience, specifically in far vision zones, with an expanded peripheral viewing field across even the largest of curved frames. The lens additionally covers the intermediate vision zones required in modern lifestyles involving frequent use of digital devices, and helps reduce the need to tilt one's head forward or back, or lower or raise nearby objects to achieve convenient viewing.

### Who it's for

Sunglass wearers wishing to enjoy the widest and most distortion-free vision outdoors, with any size or shape frame.

### Benefits

Optimal visual experience, even with large and curved fashion sunglass frame designs

Instant focus and clear vision in intermediate, far and peripheral vision zones, with dedicated support for near zone use of handheld digital devices

Seamless transition among vision zones

Featured technologies

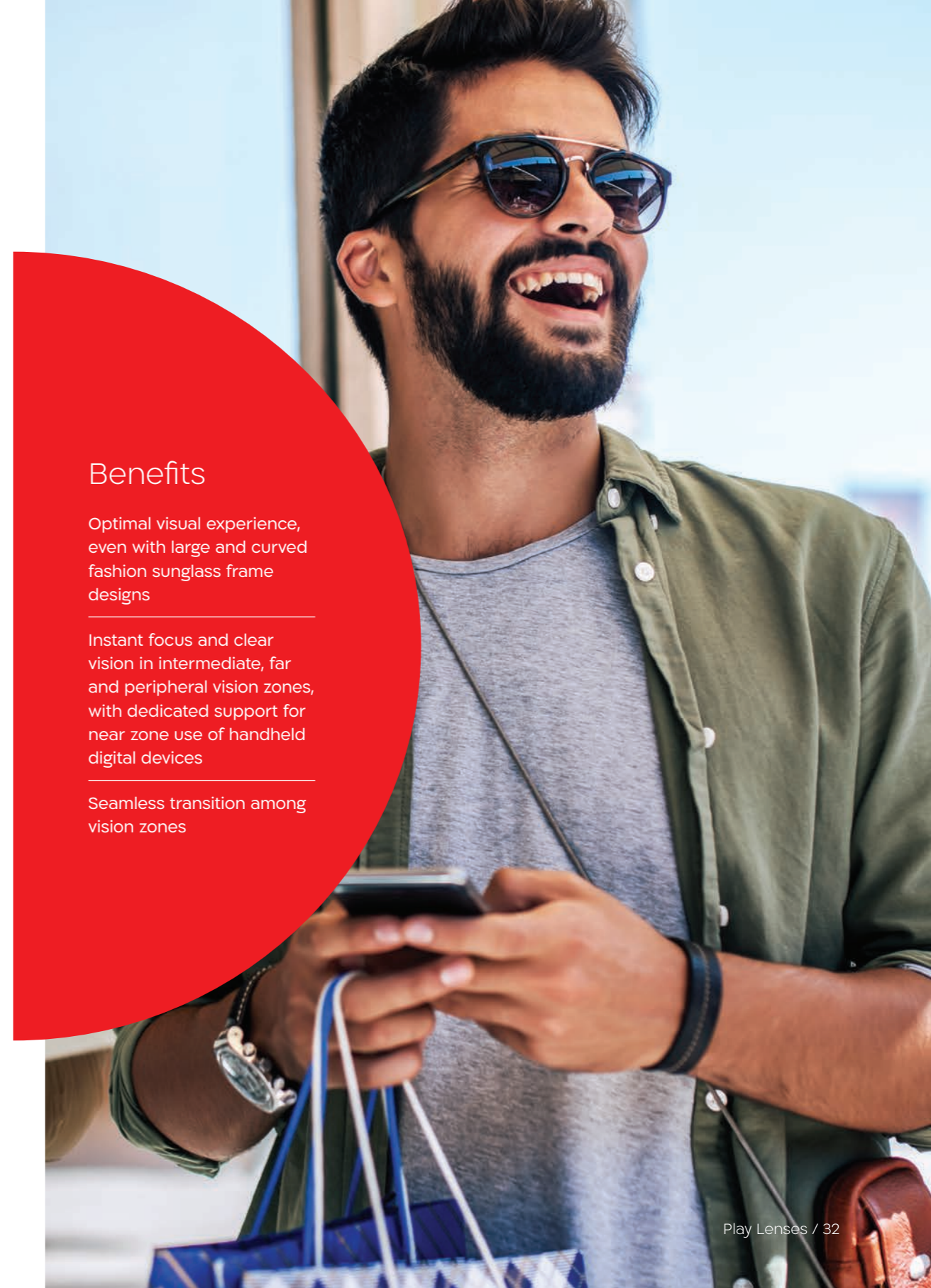

# Single Vision Lenses

Shamir Autograph® III - SV

Shamir Relax™

Shamir Autograph® II - SV

Shamir Attitude III SV™

## A highly personalized single vision lens

### What it is

A single vision lens incorporating power corrections based on precise measurement of customers' individual prescriptions, and simulation of their perceived viewing fields.

Shamir Autograph® III - SV offers single vision eyeglass wearers the sharpest and most comfortable eyesight. It does so thanks to breakthrough features, such as the highest degree of personalization to individual prescriptions, and the most precise matching of viewing experience with specific choices of frame. Eye-point technology embedded in Shamir Autograph® III - SV ensures the lens provide the widest fields of clear vision, with As-worn Quadro technology additionally guaranteeing that visual comfort and acuity precisely match the optimal viewing experience determined in optometrist measurements.

### Who it's for

Eyeglass wearers of all ages requiring the most advanced prescription-compliant vision improvement in near or far zones.

#### Benefits

High personalization, with lenses custom-designed as per individual prescriptions

Optimal visual experience with any frame of choice

The broadest possible fields of clear vision

Featured technologies



# A highly personalized single vision lens for the digital lifestyle

## What it is

An advanced single vision lens available in three variants precisely personalized to the eyesight requirements of specific eyeglass wearer ranges, and featuring an extra bit of power in its lower surface area for added visual comfort in the 15-to-27-inches digital display viewing zones.

Shamir's new Relax lenses will feature two new powers, that will provide a customized lens for any single vision wearer. The lens makes close and intermediate viewing tasks easier, and specifically helps overcome the vision and constant focusing challenges typical to continuous use of digital displays. As its name implies, Shamir Relax provides relief and helps eyeglass wearers do exactly that – relax, and enjoy greatly minimized eye dryness and fatigue, tearing, headaches and blurry vision at the end of long days in front of computer and digital device screens.

## Who it's for

The new Relax is highly recommended for anyone, with or without binocular vision issues, who experience eyestrain or end-of-day eye fatigue.

<b>NEW</b>	<b>NEW</b>	<b>NEW</b>
Relax +0.50	Relax +0.65	Relax +0.80

Featured technologies

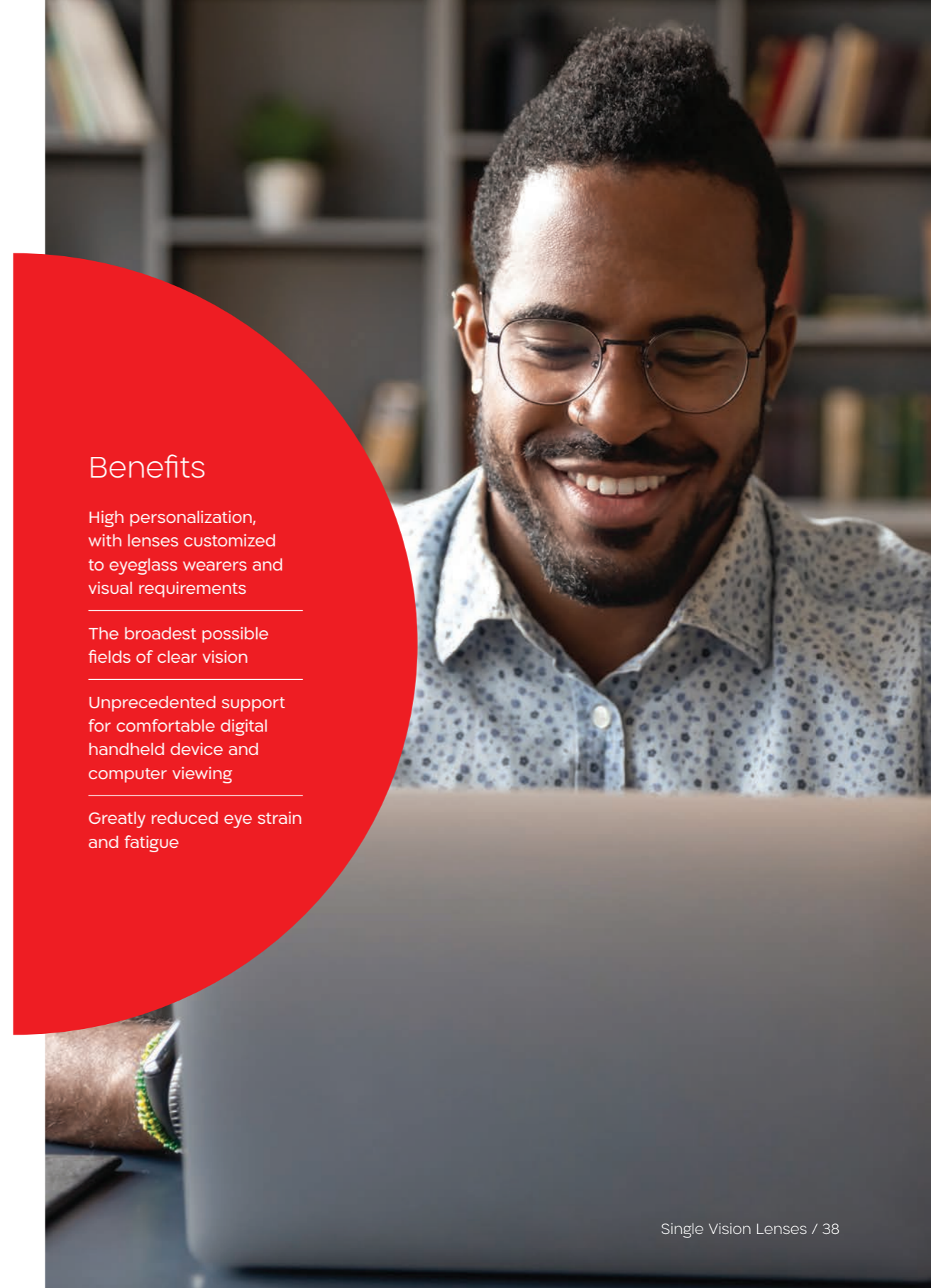

## Benefits

High personalization, with lenses customized to eyeglass wearers and visual requirements

The broadest possible fields of clear vision

Unprecedented support for comfortable digital handheld device and computer viewing

Greatly reduced eye strain and fatigue



## A personalized single vision lens providing clear and comfortable visual experience

### What it is

A single vision lens providing visual support across its entire surface, personalized as per customers' individual prescriptions.

Shamir Autograph II - SV offers single vision eyeglass wearers clear, stable and comfortable visual experience precisely where they require it. It features an aesthetically pleasing flat design, is personalized to individual prescriptions, and incorporates Eye-point technology to ensure wide fields of clear vision.

### Who it's for

Eyeglass wearers of all ages requiring prescription-compliant vision improvement in near or far zones.

Featured technologies



### Benefits

Precisely personalized to individual prescriptions

Wide fields of clear vision

## A personalized single vision lens for sunglasses

### What it is

A highly personalized single vision sunglass lens ensuring clear, undistorted vision across its entire surface, in any size or shape frame.

Shamir Attitude III SV offers single vision sunglass wearers sharp and distortion-free, prescription-personalized vision. It provides full clarity and an expanded peripheral viewing field across even the largest of curved frames, with As-worn Quadro technology additionally guaranteeing that visual comfort and acuity precisely match the desired viewing experience established in optometrist measurements.

### Who it's for

Outdoor sunglass wearers of any age requiring clear vision and prescription-specific personalization.

### Benefits

High personalization, with lenses custom-designed as per individual prescriptions

Optimal visual experience with any frame of choice, including even the most unusual fashion and performance sunglass frame designs

The broadest possible fields of clear vision

Featured technologies



# Bifocal Lenses

Shamir Duo™

## An advanced bifocal lens combining clear vision with maximum aesthetics

### What it is

A bifocal freeform lens that aesthetically conceals the line separating its upper and lower vision segments, while ensuring the smoothest transition between near and far vision zones.

Shamir Duo is designed to address the limitations of traditional bifocal lenses – namely their negative aesthetic association with elderly people, and the jarring temporary loss of sight experienced when shifting one's eyes between their near and far vision zones.

Duo overcomes these challenges by effectively eliminating the highly visible upper and lower lens segment separation line, while continuing to ensure smooth transition between near and far vision zones. The lens ultimately allows customers to enjoy many of the benefits of progressive lenses – including compatibility with a range of materials, tints and coatings – in a bifocal format ideally tailored to both visual needs and aesthetic preferences.



### Benefits

Instant focus in and smooth transition between near and far vision zones

Flawless, youthful appearance

Full compatibility with tinted, photochromic and polarized sunglass applications, as well as with a range of advanced coatings

Availability in a broad selection of materials, including high index for thin, aesthetic lenses

### Who it's for

Aesthetics-conscious eyeglass wearers, requiring near and far vision improvement, yet reluctant or otherwise unable to adapt to progressive lenses.





## Digital Precision from Just One Picture

Spark Mi™ Up is a contact-less, hands-free way to get easy, accurate, digital measurements for your patients!

By accurately capturing the PD, A, B, ED, DBL, and BVD measurements, exact calculations can be performed when fabricating the lens design to meet individual patient characteristics. The listed factors can add value to the patient's visual experience when the unique digital measurements are provided by Spark Mi™ Up:



- The lenses are larger and have a different front curve
- Lens material selection is factored into the lens calculation
- Frame selection is considered to determine the size of the lens chosen
- Distance the lens sits from the eye as well as the horizontal and vertical angle



- Intuitive and easy-to-use
- Smooth and simple customer experience
- Suitable for countertop or test room
- Adjustable arm for accurate positioning of mirror
- Clients sit comfortably with a natural head position
- Advanced new algorithm for fast and accurate measuring
- No jigs needed for standard measurements
- Synchronization between two cameras for high resolution image
- Advanced image filters for accurate marking
- Real-time measuring results which can be adjusted along the marking process

**Unit Dimensions:**  
Height from Base: Min 13 in/Max 20.5 in  
Base: 10.24 in x 10.24 in  
Total unit weight: 10.14 lb





# Coatings & Materials



## COATINGS

Shamir Glacier Plus™ .....	57-58
Shamir Glacier Anti-fog™ .....	59-60

## SPECIAL MATERIALS

Shamir Blue Zero™ .....	61-62
Shamir lens material options .....	63-64

## TRANSITIONS®

Transitions® Signature® GEN 8™ .....	65-66
Transitions® XTRActive® lenses .....	67
Transitions® Drivewear® sun lenses .....	68





## Coatings. The invisible protectors.



Lens coatings can enhance eyeglass aesthetic appearance, durability and performance, and Shamir's high quality coatings are among the world's very best.

### **Protection for eyeglasses**

Coatings are so inconspicuous, yet so effective at making glasses better, whether as a hardened layer safeguarding lenses against scratching, or a premium anti-reflective add-on reducing annoying glare and reflections. They improve visual comfort, make eyeglasses easy to clean, and even ensure that they last longer.

### **Protection for the eyes**

The broad wavebands of sunlight and artificial lighting carry some often overlooked threats, and coatings can be truly indispensable in protecting the eyes against these hidden potential hazards. They can help block ultraviolet and infrared light, for example, to avoid the risk of damage to the cornea and retina over time. Coatings can also filter out the eye fatigue- and headache-inducing blue light eyeglass wearers may be exposed to when working with computers and other backlit digital displays, or when out and about in the sun.





# Engineered to provide every moment with clarity

Shamir's Glacier PLUS coating provides comprehensive protection from the various elements your glasses may encounter on a daily basis. From dirt and dust, to static and scratches, Glacier PLUS will Reduce, Resist and Repel, keeping your lenses clean and clear.

This advanced coating is built to last. It won't wear off, makes lenses easy to clean, and keeps them constantly clear of distracting reflections. Its anti-reflective properties significantly increase light transmission, contributing to greatly improved visual experience.

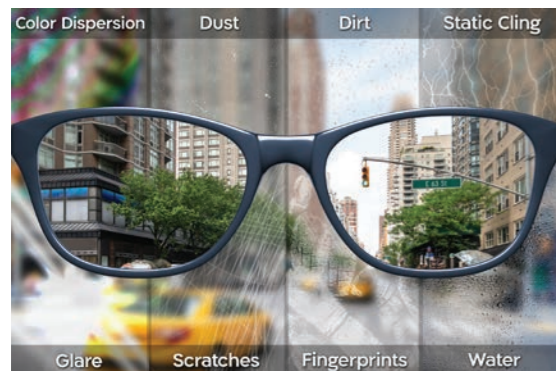

**Recommended for:**  
Eyeglass wearers of any age.

## Benefits

Minimized glare for maximum visual clarity and comfort

Enhanced durability and scratch-resistance

Anti-static, hydro - and oleo-phobic, keeping lenses clean of dust and fingerprints

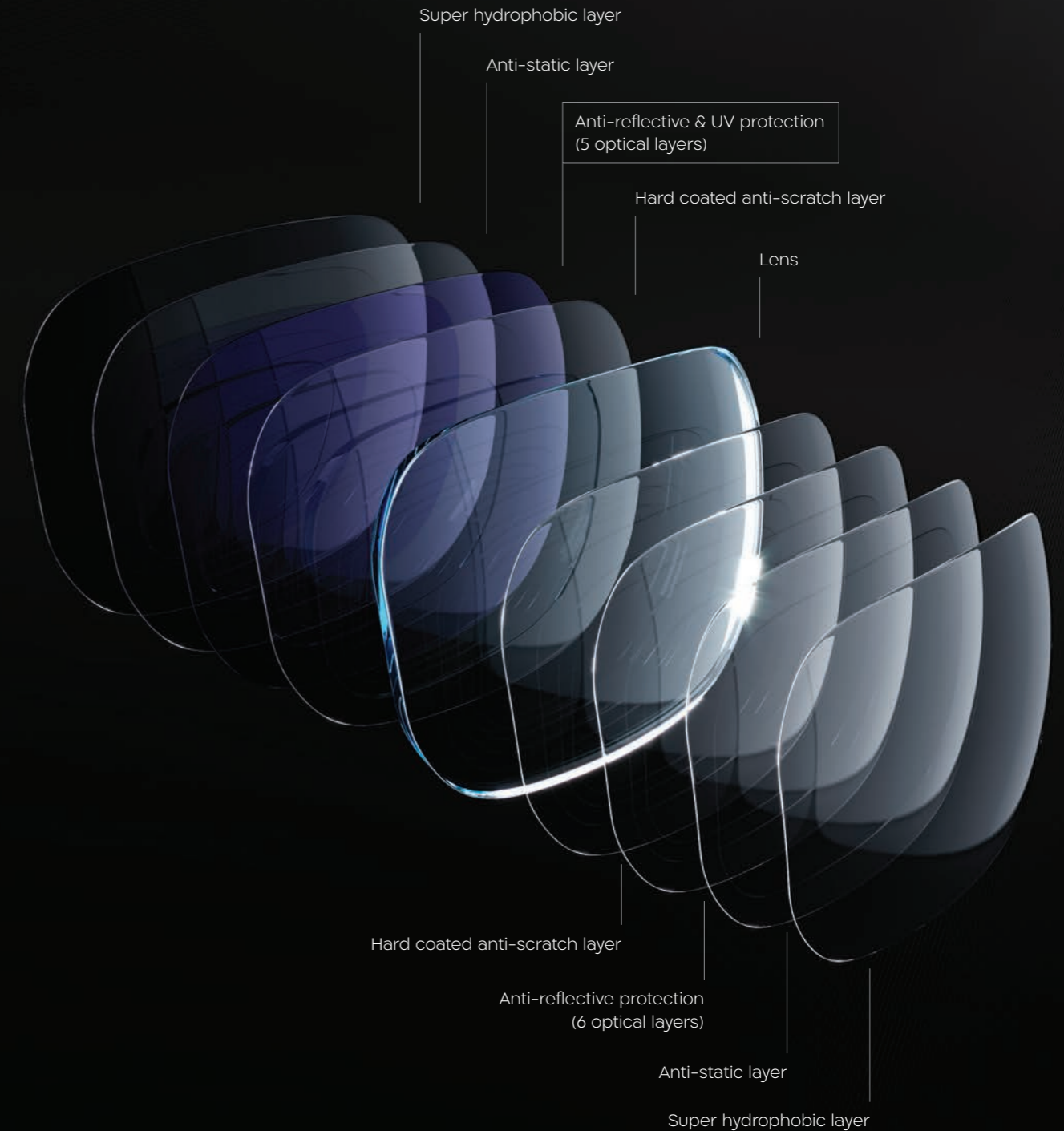

## An innovative lens coating preventing backside lens surfaces from fogging up

Any athlete or sports enthusiast wearing glasses has likely experienced the discomfort and potential hazard of blocked vision when the rear surfaces of their lenses fog up. This often occurs during strenuous activity, typically due to the body giving off increased heat, and humidity getting trapped behind their glass lenses.

The solution to this challenge is Shamir's Glacier™ Anti-fog technology, essentially an ultra-thin layer that prevents the water droplets produced by trapped humidity from forming fog on backside of the lens surfaces. Glacier Anti-fog coating effectively helps eyeglass wearers maintain performance-critical clear vision, especially during sports or other fast-paced activities. This unique technology completes Shamir's comprehensive vision solution – for enhanced sports performance.

### Recommended for:

Anyone who wears a mask, athletes or sport enthusiasts requiring clear, fog-free vision.

### Benefits

Fog-free on the backside of the lens surfaces for continuous clear vision

Ready-to-use.  
No activation needed

Available for Polycarbonate & Trivex

EN-166 standard compliant

Can be applied to any lens design and frame shape

Lenses fog up when their temperature is lower than that of the humid air given off by the body and trapped behind them.

Warm, humid air given off the body



Water droplets formed



Contact made with cold lens surface

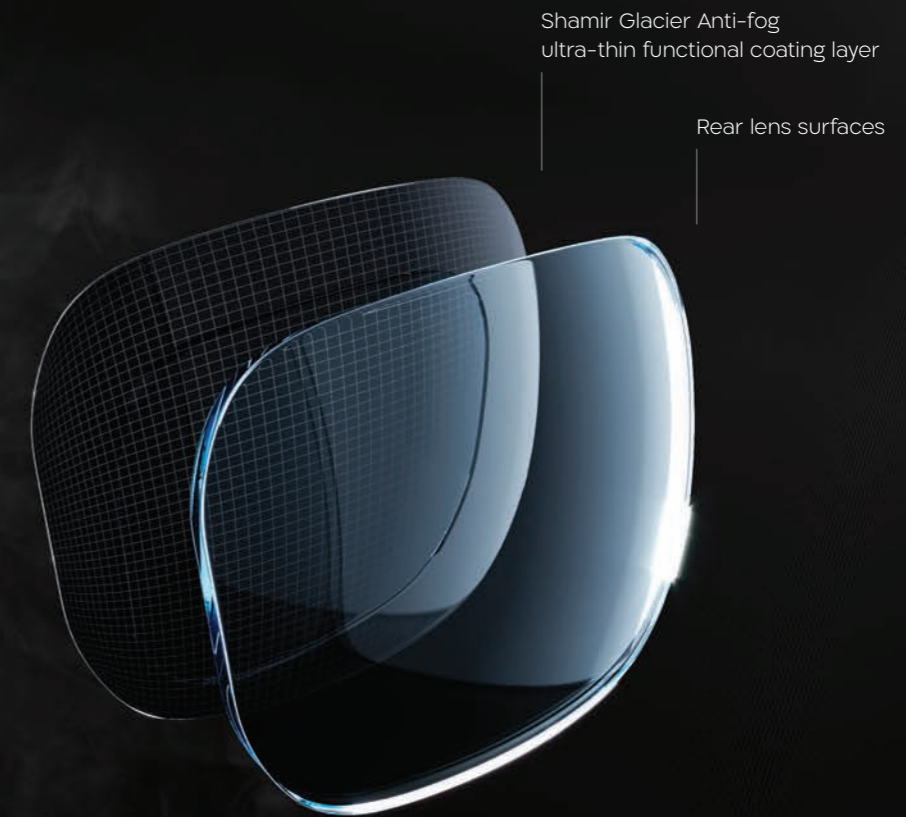



Shamir  
**Blue Zero™**

Blocking just the right amount of blue light

## Lens-embedded blue light protection

Prolonged exposure to the UV (ultraviolet) and blue light emitted by the sun and by artificial sources is a well-known threat to ocular health. It is also the potential cause of a range of other general health disorders, including disruption of natural sleep cycles.

To address this threat, Shamir has developed Blue Zero, a unique polymer formula-based lens material featuring built-in blue light protection, which effectively absorbs UV and HEV (High Energy Visible) light. In addition to blocking just the right amount of blue light to keep eyes healthy, Shamir Blue Zero lenses maintain contrast sensitivity, ensuring high visual clarity and color perception.

**Recommended for:**

Prescription or plano lens eyeglass wearers of any age.

### Benefits

Embedded ultraviolet and blue light protection greatly reduces retinal HEV light exposure and maintains visual health

Improved light transmission for enhanced visual clarity and comfort

High contrast sensitivity and color perception

Reduced eye strain and fatigue

Integrated UV protection



Materials to match every lifestyle need

## Shamir lens material options

At Shamir, we believe that materials matter. That's why we offer a broad range of lens materials for a wide variety of needs. A strong prescription can result in thick plastic lenses. We therefore

manufacture our lenses from high-index plastics or polycarbonates, which reduce lens thickness, and ultimately improve comfort and overall aesthetics.



### Lens thickness comparison

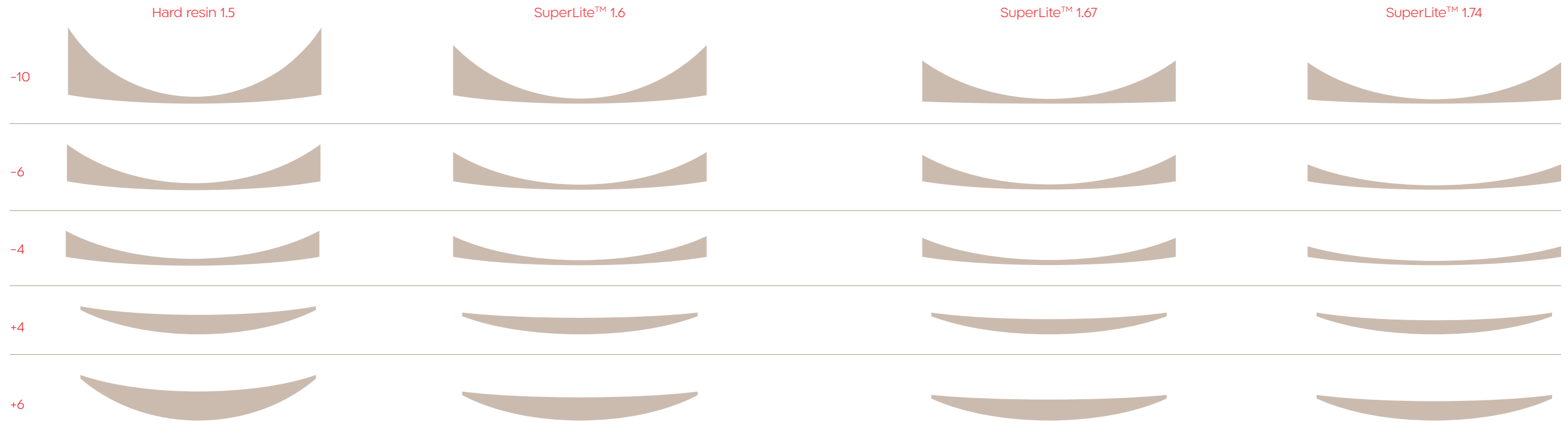

\*Pictures are for illustration purposes only



# NEW Technology NEW Frontier of performance

The perfect lens for everyday life. Constantly adapts to all light situations for better vision, comfort and protection.



Grey



Brown



Graphite green

## Benefits

Fully clear indoors

Darkens outdoors  
in seconds

Returns to clear  
faster than ever

Protects your eyes  
indoors & outdoors



Frames by CAROLINE ABRAM PARIS - Grey



Frames by ICI Berlin - Lenses Transitions® Sapphire



Coming  
Soon

## Pick your color. Choose your style.

Transitions® Signature® lenses are available in a choice of 4 vibrant style colors for you to personalize any frame and express your style.



Sapphire



Amethyst



Amber



Emerald



## Best for extra protection, even in the car

Uniquely designed to protect your eyes from the brightest sun outdoors and harsh artificial light indoors.



Grey



Brown



Graphite green

### Benefits

Extra dark outdoors, even in hot temperatures

Ultimate protection in the brightest sun / Activates in the car

Clear indoors, with a hint of protective tint

Frames by Icl Berlin - Lenses Transitions® Grey



Frames by Icl Berlin - Lenses Transitions® Brown

### Benefits

Continuously adapting to reduce glare and optimize color contrast

Better manage changing daylight and weather conditions for a safer drive

Block 100% UV rays



## Better vision behind the wheel

The only polarized sun lenses that are designed to activate both behind the windscreen and outdoors responding to UV and visible light.



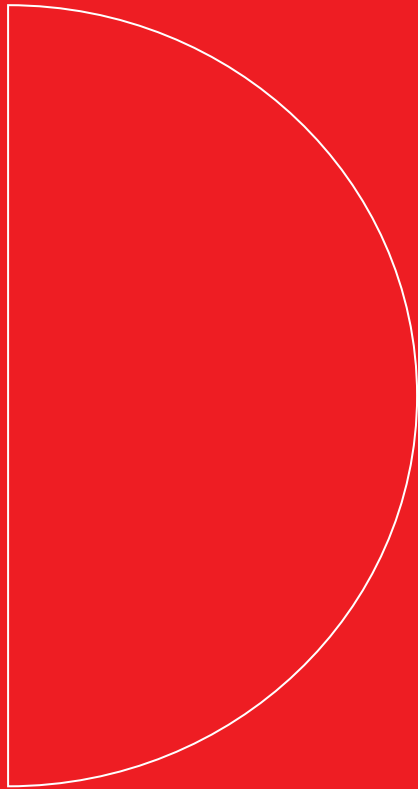

Perfect vision. Personal touch

[shamirlens.com](http://shamirlens.com)

9938 Via Pasar, San Diego CA 92126

+1 (877) 514 8330

